

series
502E2
2-Stage Servovalve
Rated flows up to 60 l/m



Features

- Standard & high response versions
- Maximum operating pressure 500 bar
- Electric feedback at main stage spool
- ISO 10372-04-04-0-92 mounting pattern
- External pilot supply (5 port)
- Suitable for 3-way or 4-way applications
- Low hysteresis & zero point drift
- High spool drive forces
- Spool in bushing design
- Long life Sapphire Technology



Sapphire ball in slot design

- Incorporated into Star designs since 1988
- Many billions of cycles per service life
- Increased spool life due to spool rotation
- Ultra low coefficient of friction sapphire to steel
- Feedback mechanism unhindered by spool rotation
- Extended warranties available

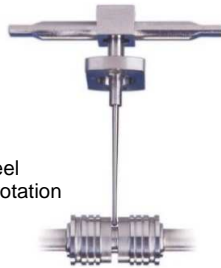

Safety

- Flame proof
- Intrinsic safety
- Class, Div & Zone coverage
- Mechanical failsafe
- Double & triple coil redundancy



Quality

- Independent audit process is our commitment on quality
- Focus on customer needs and expectations
- Delivery schedules on time
- Continual improvements on products and services
- Maintaining design and manufacturing integrity

Custom spool lap & bushing port geometries

- Zero overlap
- Overlap (closed center)
- Underlap (open center)
- Dual gain
- Asymmetric gain

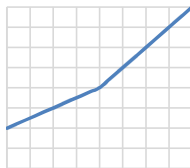
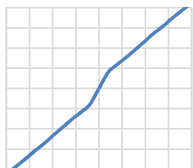
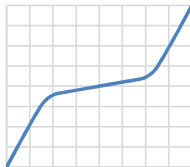
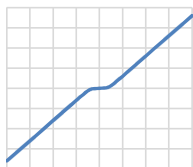
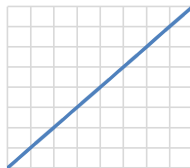

Special projects

- Compact servo designs
- Special interfaces
- Modular components



Sealing materials

- Nitrile
- Fluorocarbon (Viton)
- Ethylene-Propylene
- Fluorosilicone

Sapphire flow

- Ensuring first stage stability
- Precisely matched flow properties
- Long life in extreme environments



Special connectors

- MIL-C-5015
- MIL-DTL-38999
- Conduit style male/female
- Hermetic

Technical data

Hydraulic

Nominal flow ratings [$\pm 10\%$]	at 70 bar Δp	
	standard response	2, 4, 10, 20, 40, 60 l/m
	high response	4, 10, 20, 40 l/m
Operating pressure (max)	Ports	P, C1, C2 R X
Seal material	NBR, FPM	500 bar 315 bar 315 bar
Fluid viscosity range (recommended)		10 to 100 mm ² /s (cSt)
Fluid type		Mineral oil to ISO 11158, DIN 51524 or equivalent MIL-H-5606 Kerosene Water glycols others on request
Filter rating (recommended)	Pressure line	Beta 10 = 200 (10 μm abs), non by-pass & indicator
	Off-line	Beta 2 = 1000 (2 μm abs)
Fluid cleanliness	ISO 4406: 1999	
	minimum	16/ 14/ 11
	recommended	15/ 13/ 10

Operational parameters

Hysteresis		$\leq 0.5\%$ without dither	
Threshold		$\leq 0.1\%$ without dither	
Null shift	ΔT 40°C	$\leq 1.5\%$	
Internal leakage	140 bar supply (0.5% overlap)		
	2, 4, 10 l/m	≤ 1.7 l/min	
	20, 40, 60, 75 l/m	≤ 2.2 l/min	
Load pressure difference	1% input	$\geq 30\%$ of supply pressure can be as high as 100%	
Response time	0-100% rated spool stroke		
		standard response	
		high response	
		2, 4, 10, 20, 40 l/m	6 ms
		60 l/m	8 ms
		70 l/m	12 ms
	4, 10, 20 l/m	4 ms	
	40 l/m	6 ms	
Mounting pattern		ISO 10372-04-04-0-92 with X port	
Mounting position		Any, fixed or movable	
Weight	std unit	2.3 kg	
Design protection	EN 60529	IP 65	
Shipping protection		Sealed base plate	
Vibration		30 g all axis	
Seal material options		NBR, FPM	
Temperature range		-20 to 80 °C	

Technical data - Electrical details

Dual rail power supply +15/0/-15 V

Pin	Function	Values
A	Supply	+15 Vdc
B	Supply	-15 Vdc
C	GND	0 V
D	Input rated command (differential)	±10 V, ±10 mA
E	<i>Inverse bi-polar command signals</i>	
F	Actual spool position	±10 Vdc
PE	Protective earth	

Single rail power supply 24 V

Pin	Function	Values
A	Supply	24 Vdc
B	GND	0 V
C	Not used	
D	Input rated command (differential)	±10 V, ±10 mA
E	<i>Inverse bi-polar command signals</i>	
F	Actual spool position	±10 Vdc
PE	Protective earth	

N.B. Power supply and rated input signals are factory set, please advise preferences at time of order

Power supply	Current (mA) Ripple (mV p-p) Warning	< 100 each rail (typically 50) < 50 +15 V or -15V rail must NOT be connected to pin C (GND)
Command signal	Polarity P»C2, C1»R ±10 V input ±10 mA input	D +, E - impedance 100 Kohm impedance 1 Kohm
Spool position output	Voltage output	Output impedance <10 ohm, min. receiver impedance 1 kohm Pin F must be referenced to 0 V
Valve connector type	MIL-C-5015	MS3102E-14-SA-7P mates with MS3106E-14-SA-7SN Consult factory for more options
Standard connector orientation	also available over	C2 port C1; please advise when ordering
Connecting cable		DEF STAN 61-12, part 4 screened, 7-2-C type, 8 core (7/0.2 mm)

Technical data

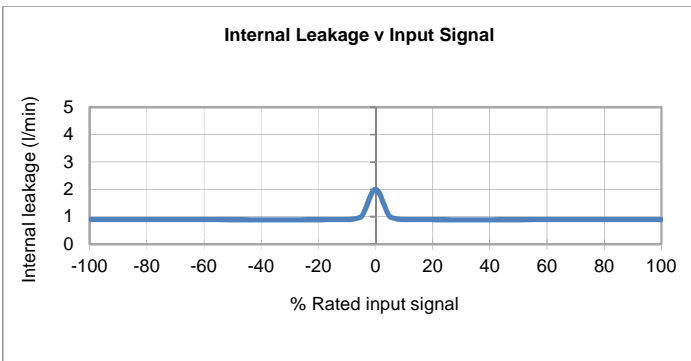
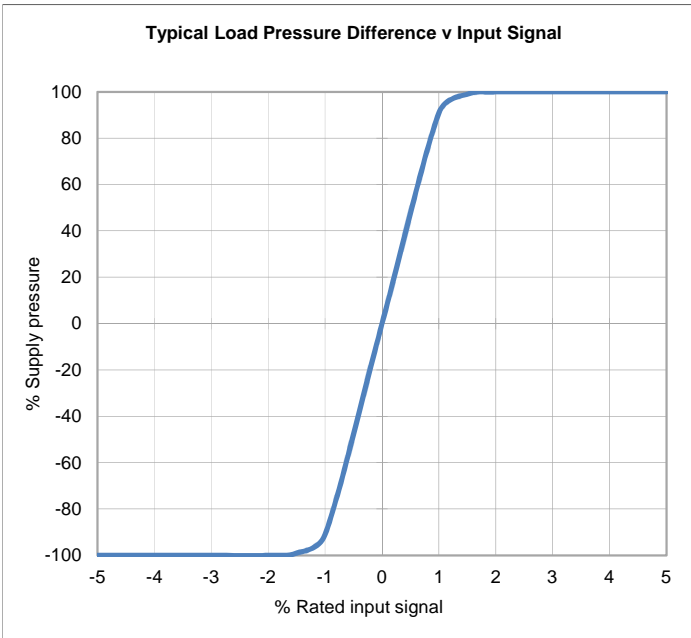
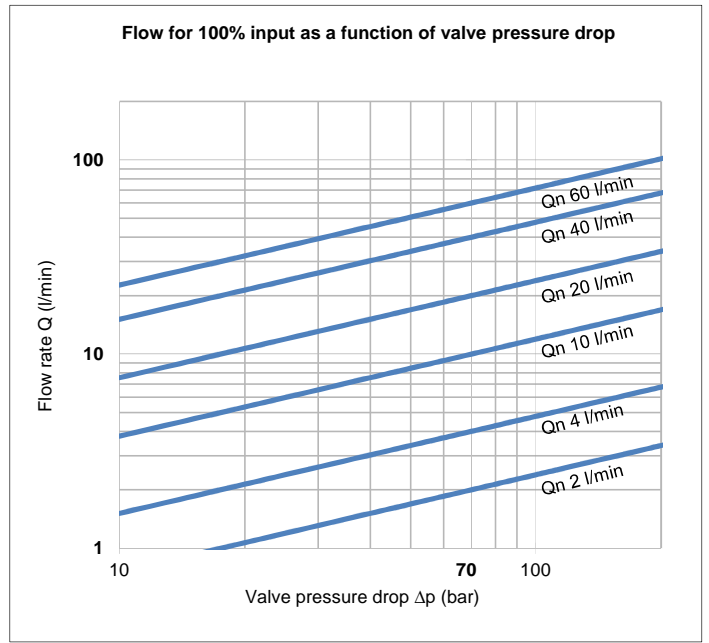
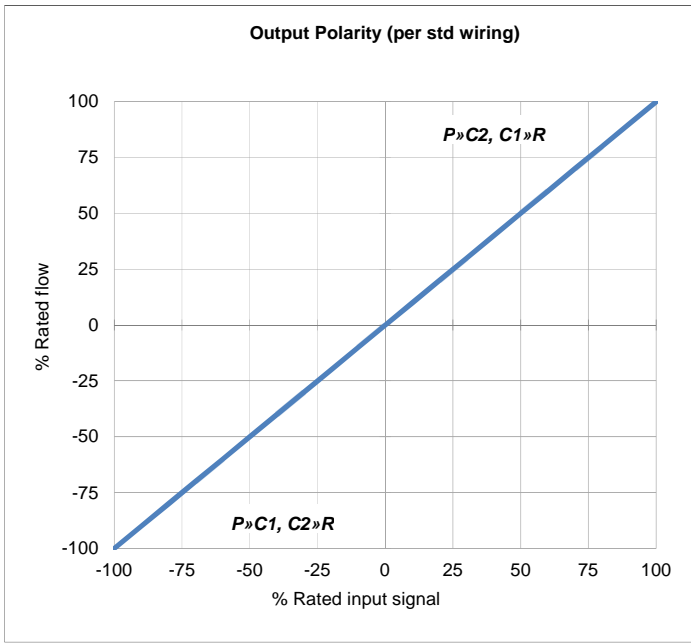

The flow tolerance for standard servovalves is $\pm 10\%$ of the rated flow at 100% rated input signal.

Rated Signal [In] is the specified input voltage or current of either polarity to produce rated flow. Rated input does not include null bias values.

Rated flow corresponds to the flow at rated input at 10 bar or 70 bar, with no load, therefore in 4-way valves there will be a pressure drop of 5 bar or 35 bar respectively across each land.

Load pressure difference versus input signal indicates typical differential pressure gain between ports C1 (A) and C2 (B) for standard lap spools. Negative and positive overlap change this characteristic significantly.

Internal leakage comprises of tare first stage and laminar leakage between spool and sleeve. With critical lap conditions in 4-way designs the leakage peaks through the null region.

Technical data

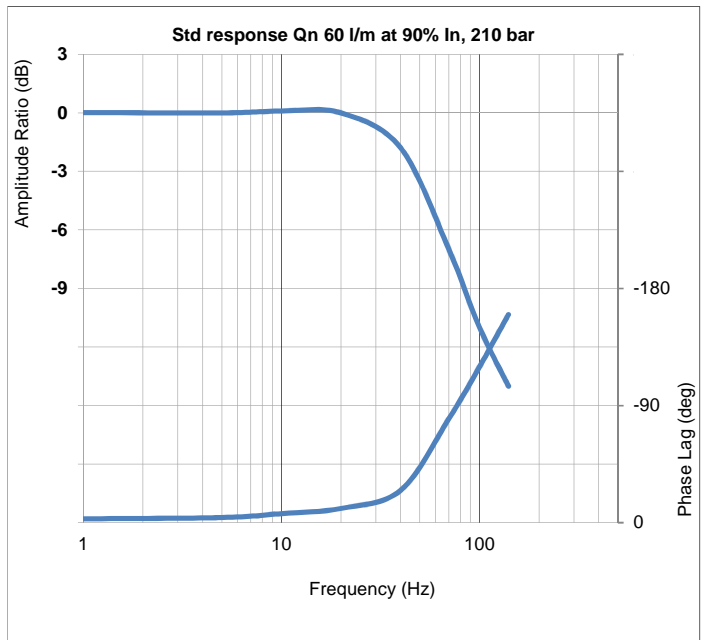
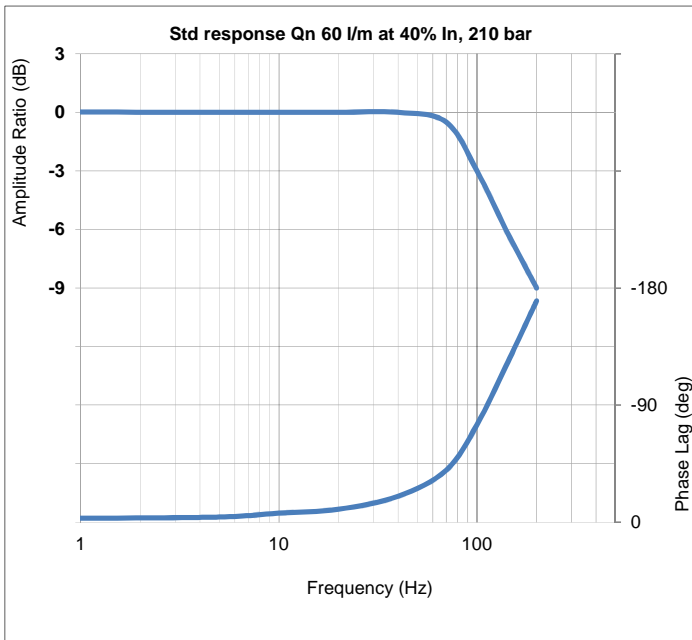
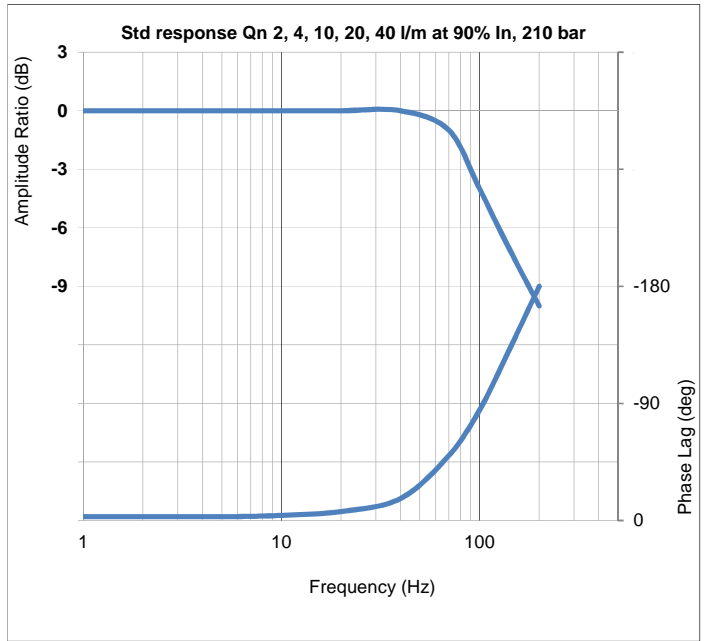
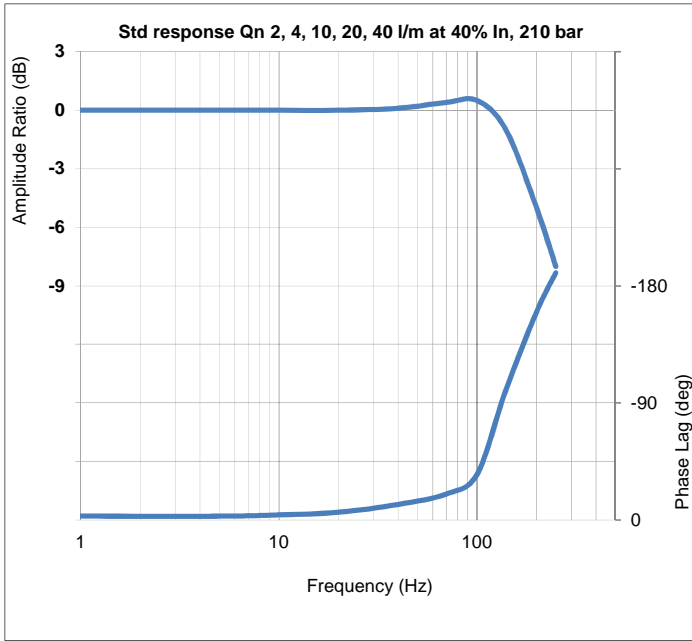

Technical data

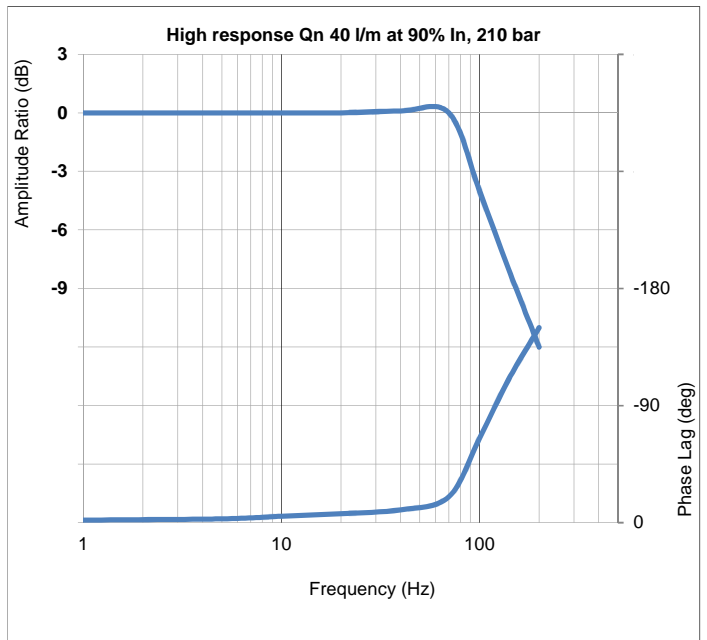
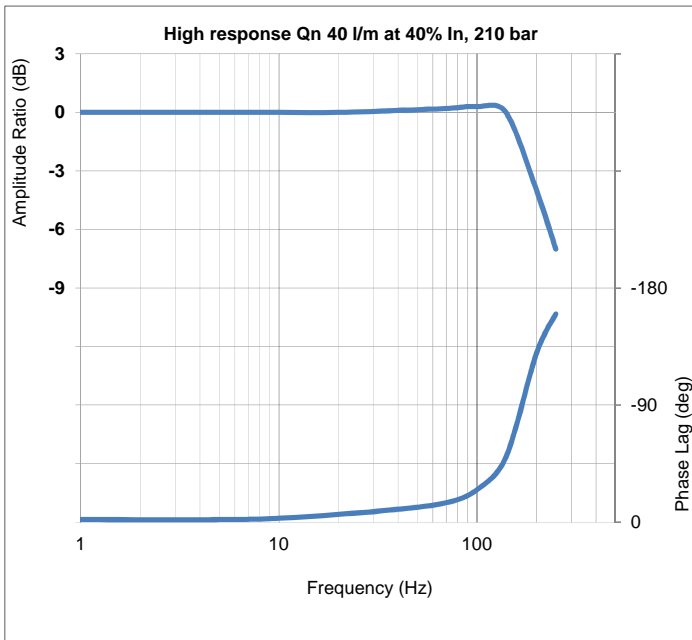
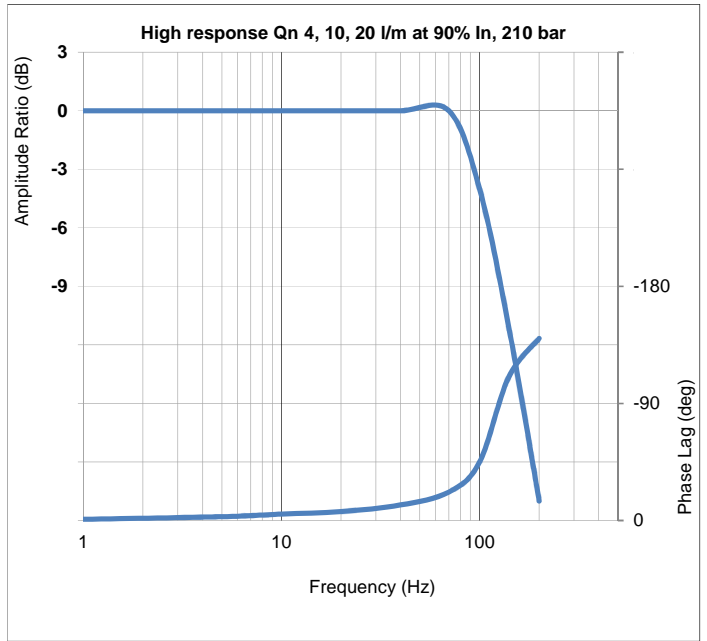
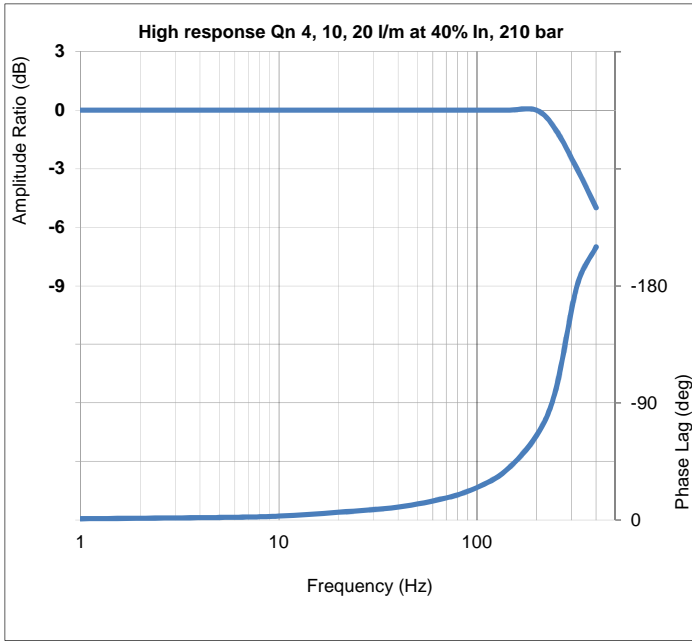

502E2 series INSTALLATION DETAILS

Mounting screws	Skt head cap screws M8 x 50 - 10.9 ISO 4762
Porting details	P, C1, C2, R ports $\varnothing 9.0$, \sqcup $\varnothing 14.25$ $\nabla 1.40$ on 22.2 P.C.D. X port $\varnothing 3.0$, \sqcup $\varnothing 14.25$ $\nabla 1.40$
Interface seals	Ports P, C1, C2, R, X - ID 10.82 x $\varnothing 1.78$ O-Ring
Null adjust	Remove screw to access potentiometer, rotate using flat blade (2mm) screwdriver to remove or apply output stage bias

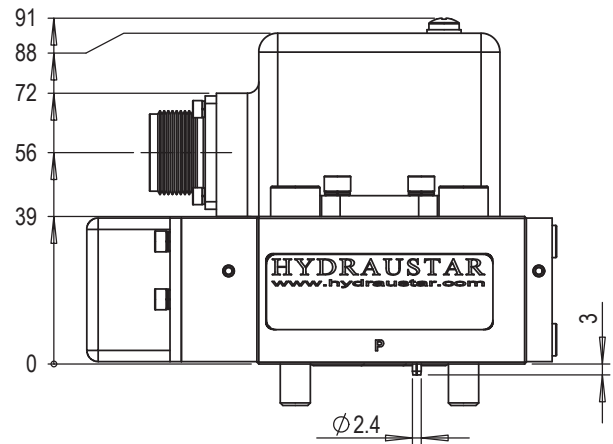
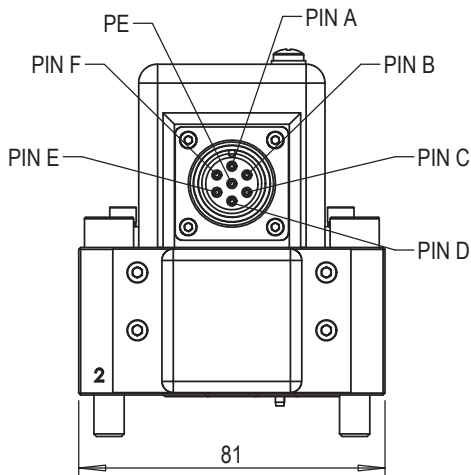
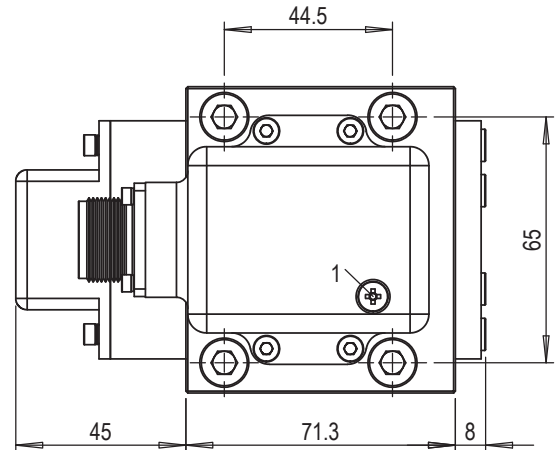
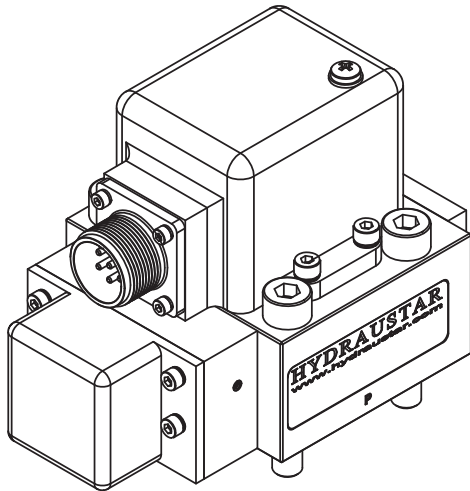

Mounting interface conforms to ISO 10372-04-04-0-92										
	P	C1	C2	R	X	F1	F2	F3	F4	G
size	$\varnothing 9$	$\varnothing 9$	$\varnothing 9$	$\varnothing 9$	$\varnothing 3$	M8	M8	M8	M8	$\varnothing 3 \nabla 5$
x	22.25	11.14	33.35	22.25	33.35	0	44.50	44.50	0	12.35
y	21.39	32.50	32.50	43.61	8.70	0	0	65	65	19.80
Surface flat within 0.01 / 100 : finish better than 0.8 μm										

